

AD-500270-01

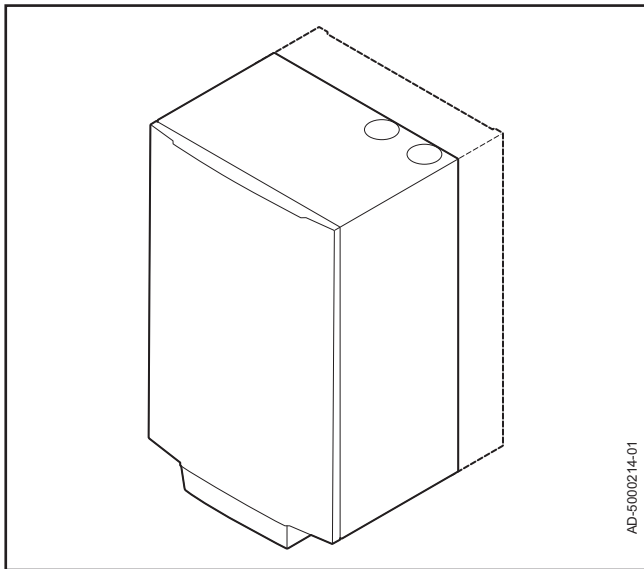









Montage instructie  
Assembly instructions  
Instructions de montage  
Montageanweisung  
Instrucciones para el montaje  
Istruzioni di montaggio

**Onderhoudsset**  
**Maintenance kit**  
**Kit maintenance**  
**Wartungsset**  
**Kit mantenimiento**  
**Kit manutenzione**



AD-5000214-01

**Inhoud verpakking - Set contents - Contenu du kit  
Inhalt des Bausatzes - Contenido del paquete - Contenuti del pacchetto**

Inhoud verpakking Set contents Contenu du kit Inhalt des Bausatzes Contenido del paquete Contenuti del pacchetto	A	B	C	D	E	F	G	H	J	K
										
<b>SET A</b> 24kW, 28kW, 35kW, 39kW	✓	✓	✓				✓		✓	✓
<b>SET B</b> 24kW, 28kW, 35kW, 39kW	✓	✓	✓				✓	✓	✓	✓
<b>SET C</b> 24kW, 28kW, 35kW, 39kW	✓	✓	✓	✓	✓	✓	✓	✓	✓	✓

AD-5000271-01

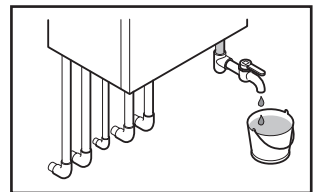
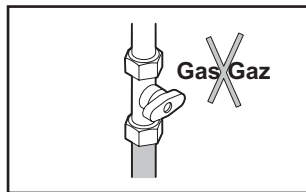
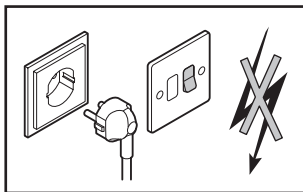

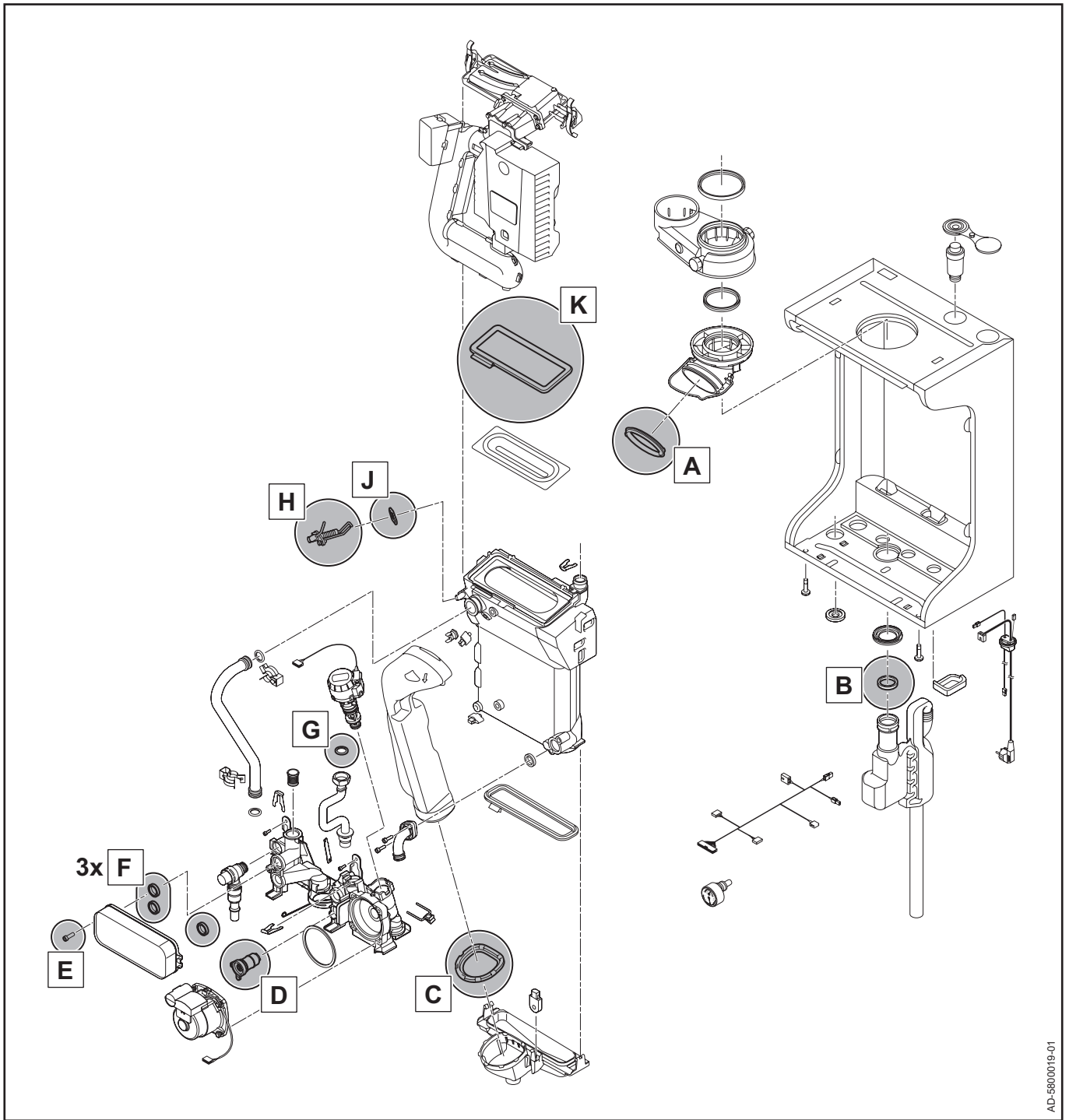

AD-5600019-01

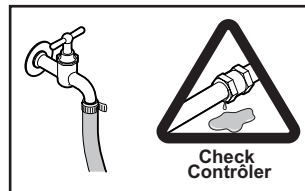
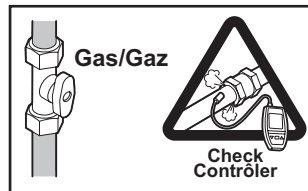
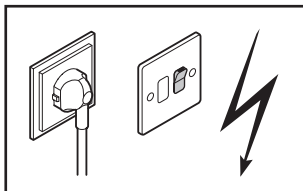

**© Copyright**

All technical and technological information contained in these technical instructions, as well as any drawings and technical descriptions supplied, remain our property and shall not be multiplied without our prior consent in writing.

Ours is a policy of continuous development. We reserve the right to alter specifications without prior notification.  
Subject to alterations.

